

MOTOmed®
next generation

Product Overview

No. 36 - valid from 01/2019

International

MOTOMed MOTION





MOTOmed

MUVI

Leg and/or arm/upper body trainer with simultaneous movement

04

MUVI



MOTOmed

LOOP

Leg or arm/upper body trainer

06

LOOP

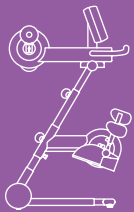

MOTOmed

GRACILE12

Leg or arm/upper body trainer for children

22

GRACILE12

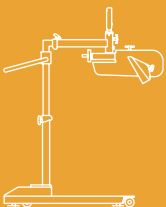

MOTOmed

LAYSON

Leg or arm/upper body trainer

26

LAYSON

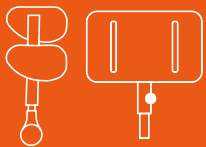

MOTOmed

ACCESSORIES

Accessories and unique product configurations

40

ACCESSORIES

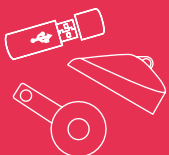

MOTOmed

UPGRADES

58

UPGRADES



MOTomed®
MUVI

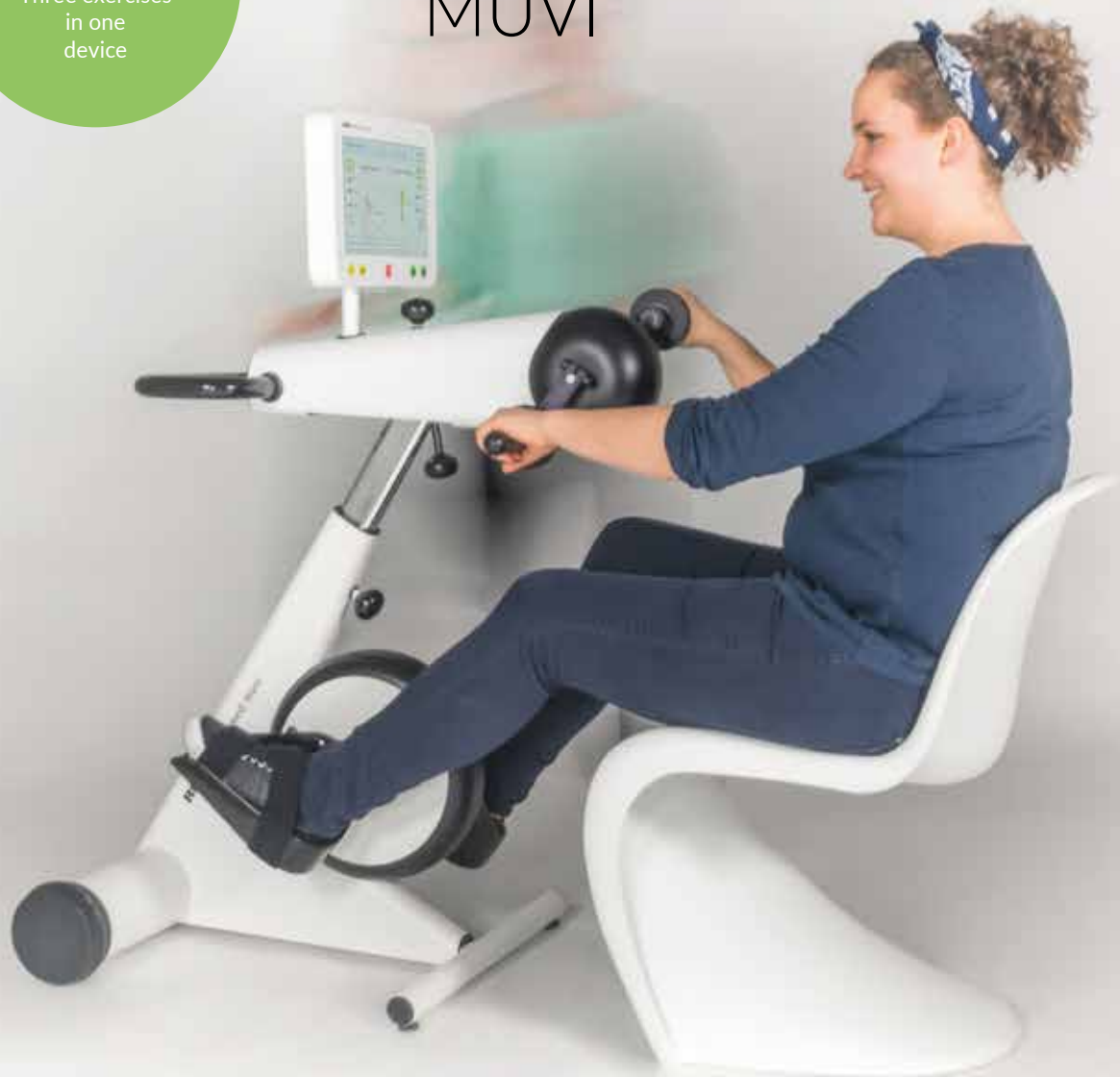

Uniquely simultaneous

MOTomed muvi users can train either **separately or simultaneously with their legs, arms and upper body**. The speed and brake intensity of the leg and arm/upper body training can be separately adjusted. The holistic MOTomed movement can effectively improve muscle strength and mobility, as well as ideally strengthen the cardiovascular system.

Non-binding fig. of MOTomed muvi

MOTomed® muvi

Leg and/or arm/upper body trainer with simultaneous movement



Order number: 300.000

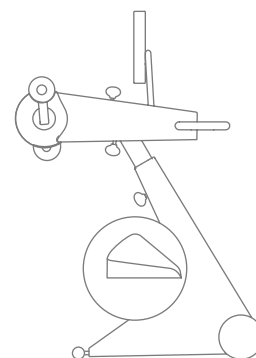

Technical data

Dimensions (L×W×H):	95–108 × 60 × 124–135 cm
Weight:	51 kg
Maximum patient weight:	135 kg
Display size:	12.1" / 30.7 cm
Classification:	Ila according to MDD 93/42/EEC
Mains voltage: 100–240 V~ / max. 120 VA, mains frequency: 47–63Hz, class II equipment / Type BF	

Basic equipment

- Simultaneous training, separately adjustable training modes for leg and arm/upper body trainer
- Colour touch display (12.1"), rotatable, inclinable
- Plastic-coated safety foot shells with fastening straps
- Plastic-coated handle
- Rotatable arm/upper body trainer, adjustable in height and distance
- Plastic-coated handles with quick release system
- 2-stage pedal radius adjustment (7 cm or 12.5 cm)
- Sturdy all-metal construction, high quality and stable, with telescopic front stand
- Easily movable with large castors (Ø 15 cm)
- Integrated operating film
- Serial interface, USB interface
- Colour: white/chrome/black

Functions

- Passive, Assistive and Active Training
- Simultaneous training of leg and arm/upper body trainer, separately adjustable (concurrent, simultaneous training)
- Individual arrangement of operating keys possible
- Electronic foot insertion aid
- Speed from 1 to 60 rpm (passive)
- Brake intensity from 0 to 20 (active)
- Motor power from 1 to 10 (passive)
- Presetting of therapy time from 0 to 120 minutes
- MovementProtection & SpasmControl
- Safety stop
- SymmetryTraining of leg and arm/upper body trainer
- Quiet, gentle and harmonious cycle movement (SmoothDriveSystem)
- Gentle starting and stopping of the movement
- Therapy and motivation programs
- Detailed biofeedback during and after training
- Export of training data and import of own programs
- Games & videos
- Slideshow via USB (delivered without USB stick)
- Language selection

Frequently used accessories (More accessories from [page 40](#) onwards)

Designation	Order No.	Page
Leg guides with plastic-coated calf shells (pair)	303.000	p. 45 ⓘ
»QuickFix« foot fastening system (pair)	265.004	p. 46 ⓘ
Hand fixation by wrist cuff (piece)	562.000	p. 48 ⓘ



MOTMed® LOOP EDITION



MOTMed loop on top

With the new and innovative height adjustment, users can adjust the height of the MOTMed loop without using tools. This feature allows the leg and arm trainer to be optimally adapted to the user, enabling patients to use the MOTMed loop from an active wheelchair, electric wheelchair, care wheelchair, a seat shell or even a chair.



Non-binding fig. of MOTMed loop.la

MOTOMed® loop Edition

The MOTOMed loop models stand for a future-oriented movement therapy in sitting position. The innovative height adjustment, modern hygiene system for professional use, a minimalistic design with a new feel, optimized dimensions and proportions, and intuitive operation have all contributed to a revamp of the MOTOMed devices to provide users with a progressive training experience.

Basic equipment

- Height adjustment of leg or arm/upper body trainer adjustable by 15 cm without tools. The pedal axle height of the leg trainer is height adjustable in the range 30 to 45 cm (measured from floor).
- Colour touch display (7"), inclinable, retractable
- Sturdy metal construction, high quality and stable
- 2-stage pedal radius adjustment (7 cm or 12.5 cm)*¹
- Closed plastic body (PC/ABS), thus easy to clean and disinfect
- Easily movable with large castors (Ø 13 cm)
- Soft Grip transport handle
- Serial interface, USB interface
- Reduced device stand width of 38.5 cm
- Colour: white/chrome/black

*¹ Not valid for MOTOMed loop models (.a)

*² Not valid for MOTOMed loop light models

*³ Only valid for MOTOMed loop models (.la)

*⁴ Only valid for MOTOMed loop kidz models

Functions

- Passive, Assistive and Active Training
- Change from leg to arm training via Touch*³
- Electronic foot insertion aid
- Passive speed from 1 to 60 rpm (90 rpm for MOTOMed loop parkinson)
- Brake intensity from 0 to 20 (active)
- Motor power from 1 to 10 (passive)
- Presetting of therapy time from 0 to 120 minutes
- MovementProtection & SpasmControl
- Safety Stop
- SymmetryTraining
- Quiet, gentle and harmonious cycle movement (SmoothDriveSystem)
- Gentle starting and stopping of the movement
- Therapy and motivation programs*²
- Detailed biofeedback during and after training
- Presetable training parameters
- Export of training data and import of own training programs*²
- Games*²
- Slideshow via USB (delivered without USB stick)*²
- Child-friendly software*⁴
- Language selection

Uniquely upgradeable

The individual MOTOMed loop devices can be adapted to different requirements by means of an upgrade bundle. Detailed information on the available MOTOMed loop extensions can be found in the [upgrade table on page 60](#).



MOTOMed loop.l

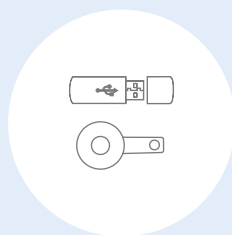

























Upgrade Bundle



MOTOMed loop.la*

*Example of upgrade

MOTomed® loop model overview

	Order No.	Designation/Description	Upgradeable	Page
	260.030	 MOTomed loop.la Leg or arm/upper body trainer	✓	9
	260.010	 MOTomed loop.l Leg trainer	✓	10
	260.020	 MOTomed loop.a Arm/upper body trainer	✓	11
	260.060	 MOTomed loop p.la (Parkinson) Leg or arm/upper body trainer for Parkinson's patients with 90 rpm	✓	12
	260.040	 MOTomed loop p.l (Parkinson) Leg trainer for Parkinson's patients with 90 rpm	✓	13
	260.120	 MOTomed loop light.la Leg and/or arm/upper body trainer, only with basic functions	✓	14
	260.100	 MOTomed loop light.l Leg trainer only with basic functions		15
	260.110	 MOTomed loop light.a Arm/upper body trainer only with basic functions		16
	260.090	 MOTomed loop kidz.la Leg or arm/upper body trainer for children and adolescents	✓	17
	260.070	 MOTomed loop kidz.l Leg trainer for children and adolescents	✓	18
	260.080	 MOTomed loop kidz.a Arm/upper body trainer for children and adolescents	✓	19
	260.039	 MOTomed loop.la prof Leg or arm/upper body trainer for professional use in hospitals	✓	21

MOTomed® loop.la

Leg or arm/upper body trainer

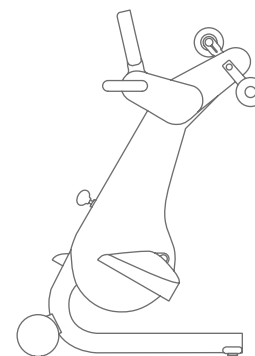

Order number: 260.030

Basic equipment (For all details, see equipment and functions, [page 7](#))

Plastic-coated safety foot shells with fastening straps (pair, incl. pedal cranks)

Soft Grip handles (pair, incl. pedal cranks)

Technical data

Dimensions (L×W×H):	70 × 60 × 107–122 cm
Weight:	33 kg
Maximum patient weight:	135 kg
Display size:	7" / 18 cm
Classification:	Ila according to MDD 93/42/EEC
Mains voltage: 100–240 V~ / max. 120 VA, mains frequency: 47–63Hz, class II equipment / Type BF	

Optional product configuration (cannot be changed later)

Designation	Order No.	Page
Gas spring support for height adjustment	265.002	p. 57 ⓘ
Special stand with reduced stand height	265.001	p. 57 ⓘ

Frequently used accessories (More accessories from [page 40](#))

Leg guides with plastic-coated calf shells (pair)	303.000	p. 45 ⓘ
»QuickFix« foot fastening system (pair)	265.004	p. 46 ⓘ
Pedal radius quick adjustment (leg trainer, pair)	507.020	p. 46 ⓘ
Hand fixation by wrist cuff (piece)	562.000	p. 48 ⓘ
Wheelchair stabilizer	100.000	p. 54 ⓘ

These upgrades are possible with MOTomed loop.la (More information from [page 58](#) onwards)

	loop.l	loop.a	loop light.la	loop light.l	loop light.a	loop p.la	loop p.l	loop kidz.la	loop kidz.l	loop kidz.a	loop.la prof
loop.la	✓	✓	✓			✓	✓	✓	✓	✓	

MOTomed® loop.l

Leg trainer



Order number: 260.010

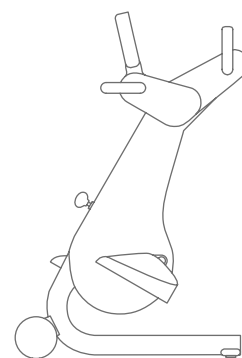

Basic equipment (For all details, see equipment and functions [page 7](#))

Plastic-coated safety foot shells with fastening straps (pair, incl. pedal cranks)
Ergonomic Soft Grip handles (pair) »cornets«

Technical data

Dimensions (L×W×H):	70 × 60 × 107–122 cm
Weight:	31 kg
Maximum patient weight:	135 kg
Display size:	7" / 18 cm
Classification:	Ila according to MDD 93/42/EEC
Mains voltage: 100–240 V~ / max. 120 VA, mains frequency: 47–63Hz, class II equipment / Type BF	

Optional product configuration (cannot be changed later)

Designation	Order No.	Page
Gas spring support for height adjustment	265.002	p. 57 ⓘ
Special stand with reduced stand height	265.001	p. 57 ⓘ

Frequently used accessories (More accessories from [page 40](#))

Leg guides with plastic-coated calf shells (pair)	303.000	p. 45 ⓘ
»QuickFix« foot fastening system (pair)	265.004	p. 46 ⓘ
Pedal radius quick adjustment (leg trainer, pair)	507.020	p. 46 ⓘ

These upgrades are possible with MOTomed loop.l (More information from [page 58](#) onwards)

	loop.la	loop.a	loop light.la	loop light.l	loop light.a	loop p.la	loop p.l	loop kidz.la	loop kidz.l	loop kidz.a	loop.la prof
loop.l	✓	✓	✓			✓	✓	✓	✓	✓	

MOTomed® loop.a

Arm/upper body trainer

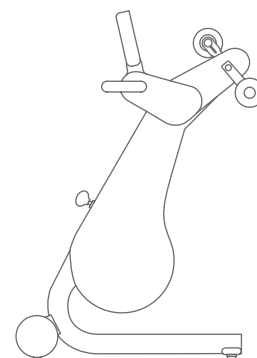

Order number: 260.020

Basic equipment (For all details, see equipment and functions [page 7](#))

Soft Grip handles (pair, incl. pedal cranks)

Technical data

Dimensions (L×W×H):	70 × 60 × 107–122 cm
Weight:	28 kg
Maximum patient weight:	135 kg
Display size:	7" / 18 cm
Classification:	IIa according to MDD 93/42/EEC
Mains voltage: 100–240 V~ / max. 120 VA, mains frequency: 47–63Hz, class II equipment / Type BF	

Optional product configuration (cannot be changed later)

Designation	Order No.	Page
Gas spring support for height adjustment	265.002	p. 57 ⓘ
Special stand with reduced stand height	265.001	p. 57 ⓘ

Frequently used accessories (More accessories from [page 40](#))

Hand fixation by wrist cuff (piece)	562.000	p. 48 ⓘ
Tetra handles (pair)	555.000	p. 50 ⓘ
Vertical handles with hand rests (pair)	557.000	p. 51 ⓘ

These upgrades are possible with MOTomed loop.a (More information from [page 58](#) onwards)

	loop.la	loop.l	loop light.la	loop light.l	loop light.a	loop p.la	loop p.l	loop kidz.la	loop kidz.l	loop kidz.a	loop.la prof
loop.a	✓	✓	✓			✓	✓	✓	✓	✓	

MOTomed® loop p.la

Leg or arm/upper body trainer (90 rpm)

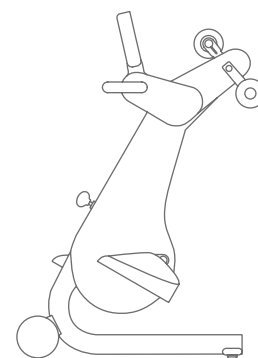

Order number: 260.060

Basic equipment (For all details, see equipment and functions [page 7](#))

Plastic-coated safety foot shells with fastening straps (pair, incl. pedal cranks)
Soft Grip handles (pair, incl. pedal cranks)

Technical data

Dimensions (L×W×H):	70 × 60 × 107-122 cm
Weight:	33 kg
Maximum patient weight:	135 kg
Display size:	7" / 18 cm
Classification:	Ila according to MDD 93/42/EEC
Mains voltage: 100-240 V~ / max. 120 VA, mains frequency: 47-63Hz, class II equipment / Type BF	

Optional product configuration (cannot be changed later)

Designation	Order No.	Page
Gas spring support for height adjustment	265.002	p. 57 ⓘ
Special stand with reduced stand height	265.001	p. 57 ⓘ

Frequently used accessories (More accessories from [page 40](#) onwards)

Leg guides with plastic-coated calf shells (pair)	303.000	p. 45 ⓘ
»QuickFix« foot fastening system (pair)	265.004	p. 46 ⓘ
Hand fixation by wrist cuff (piece)	562.000	p. 48 ⓘ
Vertical handles with hand rests (pair)	557.000	p. 51 ⓘ

These upgrades are possible with MOTomed loop p.la (More information from [page 58](#) onwards)

	loop.la	loop.l	loop.a	loop light.la	loop light.l	loop light.a	loop p.l	loop kidz.la	loop kidz.l	loop kidz.a	loop.la prof
loop p.la	✓	✓	✓	✓			✓	✓	✓	✓	

MOTomed® loop p.l

Leg trainer (90 rpm)



Parkinson

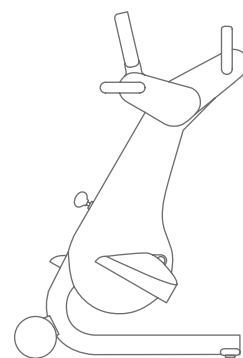

Order number: 260.040

Basic equipment (For all details, see equipment and functions [page 7](#))

Plastic-coated safety foot shells with fastening straps (pair, incl. pedal cranks)

Ergonomic Soft Grip handles (pair) »cornets«

Technical data

Dimensions (L×W×H):	70 × 60 × 107–122 cm
Weight:	31 kg
Maximum patient weight:	135 kg
Display size:	7" / 18 cm
Classification:	Ila according to MDD 93/42/EEC

Mains voltage: 100–240 V~ / max. 120 VA, mains frequency: 47–63Hz, class II equipment / Type BF

Optional product configuration (cannot be changed later)

Designation	Order No.	Page
Gas spring support for height adjustment	265.002	p. 57 ⓘ
Special stand with reduced stand height	265.001	p. 57 ⓘ

Frequently used accessories (More accessories from [page 40](#) onwards)

Leg guides with plastic-coated calf shells (pair)	303.000	p. 45 ⓘ
»QuickFix« foot fastening system (pair)	265.004	p. 46 ⓘ
Pedal radius quick adjustment (leg trainer, pair)	507.020	p. 46 ⓘ
Wheelchair stabilizer	100.000	p. 54 ⓘ

These upgrades are possible with MOTomed loop p.l (More information from [page 58](#) onwards)

	loop.la	loop.l	loop.a	loop light.la	loop light.l	loop light.a	loop p.la	loop kidz.la	loop kidz.l	loop kidz.a	loop.la prof
loop p.l	✓	✓	✓	✓			✓	✓	✓	✓	

MOTomed® loop light.la

Leg or arm/upper body trainer



Order number: 260.120

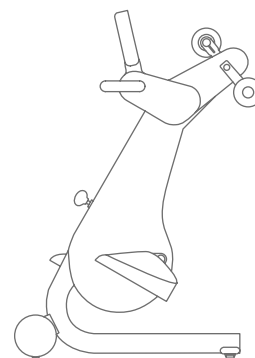

Basic equipment (For all details, see equipment and functions [page 7](#))

Soft Grip safety foot shells with fastening straps (pair, incl. pedal cranks)

Soft Grip handles (pair, incl. pedal cranks)

Technical data

Dimensions (L×W×H):	70 × 60 × 107–122 cm
Weight:	33 kg
Maximum patient weight:	135 kg
Display size:	7" / 18 cm
Classification:	IIa according to MDD 93/42/EEC
Mains voltage: 100–240 V~ / max. 120 VA, mains frequency: 47–63Hz, class II equipment / Type BF	

Optional product configuration (cannot be changed later)

Designation	Order No.	Page
Gas spring support for height adjustment	265.002	p. 57 ⓘ
Special stand with reduced stand height	265.001	p. 57 ⓘ

Frequently used accessories (More accessories from [page 40](#) onwards)

Leg guides with calf shells (pair)	302.000	p. 44 ⓘ
»QuickFix« foot fastening system (pair)	265.004	p. 46 ⓘ
Pedal radius quick adjustment (leg trainer, pair)	507.020	p. 46 ⓘ
Hand fixation by wrist cuff (piece)	562.000	p. 48 ⓘ

These upgrades are possible with MOTomed loop light.la (More information from [page 58](#) onwards)

	loop.la	loop.l	loop.a	loop light.l	loop light.a	loop p.la	loop p.l	loop kidz.la	loop kidz.l	loop kidz.a	loop.la prof
loop light.la	✓	✓	✓			✓	✓	✓	✓	✓	

MOTomed® loop light.I

Leg trainer



Order number: 260.100

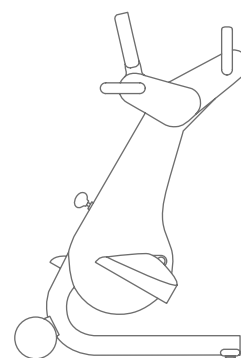

Basic equipment (For all details, see equipment and functions [page 7](#))

Soft Grip safety foot shells with fastening straps (pair, incl. pedal cranks)
Ergonomic Soft Grip handles (pair) »cornets«

Technical data

Dimensions (L×W×H):	70 × 60 × 107–122 cm
Weight:	30 kg
Maximum patient weight:	135 kg
Display size:	7" / 18 cm
Classification:	Ila according to MDD 93/42/EEC
Mains voltage: 100–240 V~ / max. 120 VA, mains frequency: 47–63Hz, class II equipment / Type BF	

Optional product configuration (cannot be changed later)

Designation	Order No.	Page
Gas spring support for height adjustment	265.002	p. 57 ⓘ
Special stand with reduced stand height	265.001	p. 57 ⓘ

Frequently used accessories (More accessories from [page 40](#) onwards)

Leg guides with plastic-coated calf shells (pair)	302.000	p. 44 ⓘ
»QuickFix« foot fastening system (pair)	265.004	p. 46 ⓘ
Pedal radius quick adjustment (leg trainer, pair)	507.020	p. 46 ⓘ
Wheelchair stabilizer	100.000	p. 54 ⓘ

These upgrades are possible with MOTomed loop light.I (More information from [page 58](#) onwards)

	loop.la	loop.l	loop.a	loop light.la	loop light.a	loop p.la	loop p.l	loop kidz.la	loop kidz.l	loop kidz.a	loop.la prof
loop light.I	No upgrades possible for MOTomed loop light.I										

MOTomed® loop light.a

Arm/upper body trainer



Order number: 260.110

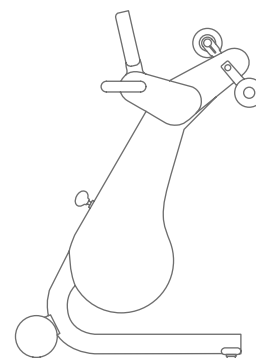

Basic equipment (For all details, see equipment and functions [page 7](#))

Soft Grip handles (pair, incl. pedal cranks)

Technical data

Dimensions (L×W×H):	70 × 60 × 107-122 cm
Weight:	27 kg
Maximum patient weight:	135 kg
Display size:	7" / 18 cm
Classification:	Ila according to MDD 93/42/EEC
Mains voltage: 100-240 V~ / max. 120 VA, mains frequency: 47-63Hz, class II equipment / Type BF	

Optional product configuration (cannot be changed later)

Designation	Order No.	Page
Gas spring support for height adjustment	265.002	p. 57 ⓘ
Special stand with reduced stand height	265.001	p. 57 ⓘ

Frequently used accessories (More accessories from [page 40](#) onwards)

Hand fixation by wrist cuff (piece)	562.000	p. 48 ⓘ
Tetra handles (pair)	555.000	p. 50 ⓘ
Vertical handles with hand rests (pair)	557.000	p. 51 ⓘ
Wheelchair stabilizer	100.000	p. 54 ⓘ

These upgrades are possible with MOTomed loop light.a (More information from [page 58](#) onwards)

	loop.la	loop.l	loop.a	loop light.la	loop light.l	loop p.la	loop p.l	loop kidz.la	loop kidz.l	loop kidz.a	loop.la prof
loop light.a	No upgrades possible for MOTomed loop light.a										

MOTomed® loop kidz.la

Leg or arm/upper body trainer

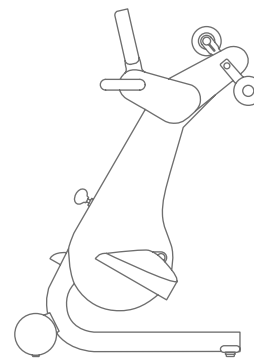

Order number: 260.090

Basic equipment (For all details, see equipment and functions [page 7](#))

Plastic-coated safety foot shells with fastening straps (pair, incl. pedal cranks)

Soft Grip handles (pair, incl. pedal cranks)

Technical data

Dimensions (L×W×H):	70 × 60 × 107–122 cm
Weight:	33 kg
Maximum patient weight:	135 kg
Display size:	7" / 18 cm
Classification:	Ila according to MDD 93/42/EEC
Mains voltage: 100–240 V~ / max. 120 VA, mains frequency: 47–63Hz, class II equipment / Type BF	

Optional product configuration (cannot be changed later)

Designation	Order No.	Page
Gas spring support for height adjustment	265.002	p. 57 ⓘ
Special stand with reduced stand height	265.001	p. 57 ⓘ

Frequently used accessories (More accessories from [page 40](#) onwards)

Leg guides with plastic-coated calf shells (pair)	303.000	p. 45 ⓘ
»QuickFix« foot fastening system (pair)	265.004	p. 46 ⓘ
Hand fixation by wrist cuff, size S (piece)	562.020	p. 48 ⓘ

These upgrades are possible with MOTomed kidz.la (More information from [page 58](#) onwards)

	loop.la	loop.l	loop.a	loop light.la	loop light.l	loop light.a	loop p.la	loop p.l	loop kidz.l	loop kidz.a	loop.la prof
loop kidz.la	✓	✓	✓	✓			✓	✓	✓	✓	

MOTomed® loop kidz.I

Leg trainer

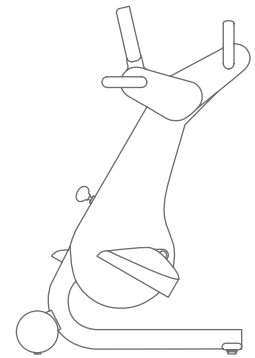

Order number: 260.070

Basic equipment (For all details, see equipment and functions [page 7](#))

Plastic-coated safety foot shells with fastening straps (pair, incl. pedal cranks)
Ergonomic Soft Grip handles (pair) »cornets«

Technical data

Dimensions (L×W×H):	70 × 60 × 107–122 cm
Weight:	31 kg
Maximum patient weight:	135 kg
Display size:	7" / 18 cm
Classification:	Ila according to MDD 93/42/EEC
Mains voltage: 100–240 V~ / max. 120 VA, mains frequency: 47–63Hz, class II equipment / Type BF	

Optional product configuration (cannot be changed later)

Designation	Order No.	Page
Gas spring support for height adjustment	265.002	p. 57 ⓘ
Special stand with reduced stand height	265.001	p. 57 ⓘ

Frequently used accessories (More accessories from [page 40](#) onwards)

Leg guides with plastic-coated calf shells (pair)	303.000	p. 45 ⓘ
»QuickFix« foot fastening system (pair)	265.004	p. 46 ⓘ
Pedal radius quick adjustment (leg trainer, pair)	507.020	p. 46 ⓘ

These upgrades are possible with MOTomed kidz.I (More information from [page 58](#) onwards)

	loop.la	loop.l	loop.a	loop light.la	loop light.l	loop light.a	loop p.la	loop p.l	loop kidz.la	loop kidz.a	loop.la prof
loop kidz.I	✓	✓	✓	✓			✓	✓	✓	✓	

MOTomed® loop kidz.a

Arm/upper body trainer



Order number: 260.080

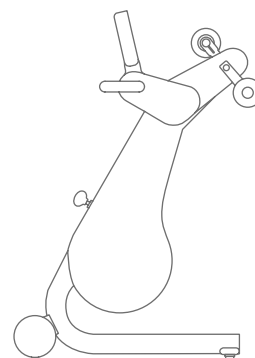

Basic equipment (For all details, see equipment and functions [page 7](#))

Soft Grip handles (pair, incl. pedal cranks)

Technical data

Dimensions (L×W×H):	70 × 60 × 107–122 cm
Weight:	28 kg
Maximum patient weight:	135 kg
Display size:	7" / 18 cm
Classification:	IIa according to MDD 93/42/EEC
Mains voltage: 100–240 V~ / max. 120 VA, mains frequency: 47–63Hz, class II equipment / Type BF	

Optional product configuration (cannot be changed later)

Designation	Order No.	Page
Gas spring support for height adjustment	265.002	p. 57 ⓘ
Special stand with reduced stand height	265.001	p. 57 ⓘ

Frequently used accessories (More accessories from [page 40](#) onwards)

Hand fixation by wrist cuff, size S (piece)	562.020	p. 48 ⓘ
Tetra handles (pair)	555.000	p. 50 ⓘ
Forearm shells with arm cuffs, size S (pair)	556.004	p. 53 ⓘ
Wheelchair stabilizer for children	100.020	p. 54 ⓘ

These upgrades are possible with MOTomed kidz.a (More information from [page 58](#) onwards)

	loop.la	loop.l	loop.a	loop light.la	loop light.l	loop light.a	loop p.la	loop p.l	loop kidz.la	loop kidz.l	loop.la prof
loop kidz.a	✓	✓	✓	✓			✓	✓	✓	✓	

MOTomed® PROFESSIONAL SERIES



For clinics and rehabilitation facilities

The MOTomed Professional Series are tailor-made devices for versatile use in clinics and rehabilitation facilities.

MOTomed loop.la prof includes the following special features:

- 1 Plastic-coated safety foot shells
- 2 Leg guides with plastic-coated calf shells and disinfectable fastening straps
- 3 »QuickFix« foot fastening system
- 4 Plastic-coated handles with quick release system
- 5 Gas spring support for height adjustment
- 6 Pedal radius quick adjustment (leg trainer, pair)



Non-binding fig. of MOTomed loop.la prof

MOTomed® loop.la prof

Leg or arm/upper body trainer

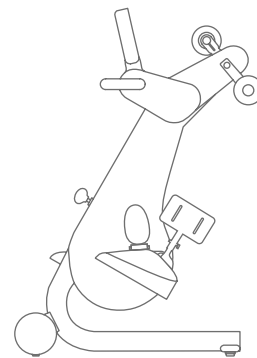

Order number: 260.039

Basic equipment (For all details, see equipment and functions [page 7](#))

- Plastic-coated safety foot shells (pair, incl. pedal cranks)
- Leg guides with plastic-coated calf shells (pair) and disinfectable fastening straps
- »QuickFix« foot fastening system (pair)
- Plastic-coated handles with quick release system (pair, incl. pedal cranks)
- Gas spring support for height adjustment
- Pedal radius quick adjustment (leg trainer, pair)

Technical data

Dimensions (L×W×H):	70 × 60 × 107–122 cm
Weight:	35 kg
Maximum patient weight:	135 kg
Display size:	7" / 18 cm
Classification:	Ila according to MDD 93/42/EEC
Mains voltage: 100–240 V~ / max. 120 VA, mains frequency: 47–63Hz, class II equipment / Type BF	

Optional product configuration (cannot be changed later)

Designation	Order No.	Page
Special stand with reduced stand height	265.001	p. 57 ⓘ

Frequently used accessories (More accessories from [page 40](#) onwards)

Hand fixation by wrist cuff (piece)	562.000	p. 48 ⓘ
Wheelchair stabilizer	100.000	p. 54 ⓘ

These upgrades are possible with MOTomed loop.la (More information from [page 58](#) onwards)

	loop.la	loop.l	loop.a	loop light.la	loop light.l	loop light.a	loop p.la	loop p.l	loop kidz.la	loop kidz.l	loop kidz.a
loop.la prof							✓				



MOTomed® GRACILE12



MOTomed gracile12 grows with you

The MOTomed gracile12 grows with the child thanks to a wide range of adjustment options. For example, the **pedal axle with foot shells is infinitely height adjustable**. The MOTomed gracile12 is available as a leg trainer but also as a leg or arm/upper body trainer to meet the different patient requirements.

Non-binding fig. of MOTomed gracile12 leg trainer

MOTomed® gracile12

Uniquely child-friendly

The MOTomed gracile12 was specially developed for children and small people with limited mobility. From a height of about 90 cm, children and adults can enjoy the efficient MOTomed movement therapy with safety functions, motivational games and therapy programs. If required, the leg trainer can be extended with the arm/upper body trainer and other accessories. The quiet motor is conducive for both concentrated therapy sessions as well as for exercising at home.

Basic equipment

- Pediatric safety foot shells and pediatric leg guides with calf shells
- Smaller inner diameter of 12 cm
- Sturdy full metal construction, high quality and stable
- Large, user-friendly display (5.7")
- Height adjustment of the pedal axle from 26 to 46 cm
- 2-stage pedal radius adjustment (3.5 cm or 7 cm)
- Easily movable with large castors (Ø 13 cm)
- Telescopic front stand
- Colour: blue/white/chrome

Functions

- Passive, Assistive and Active Training
- Electronic foot insertion aid
- Speed from 1 to 60 rpm (passive)
- Brake intensity from 0 to 20 (active)
- Motor power from 1 to 10 (passive)
- Presetting of therapy time from 0 to 120 minutes
- MovementProtection & SpasmControl
- Quiet, gentle and harmonious cycle movement (SmoothDriveSystem)
- Gentle starting and stopping of the movement
- Safety stop and SymmetryTraining
- Therapy and motivation programs
- Detailed biofeedback during and after training
- Games
- Language selection

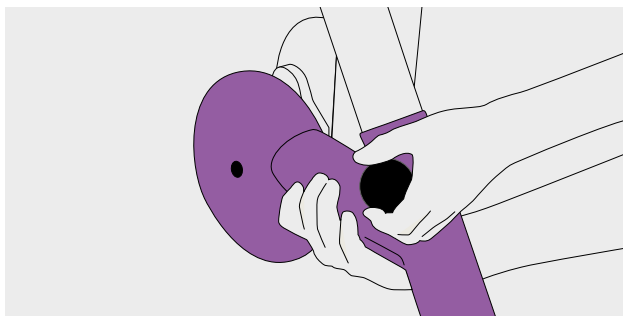

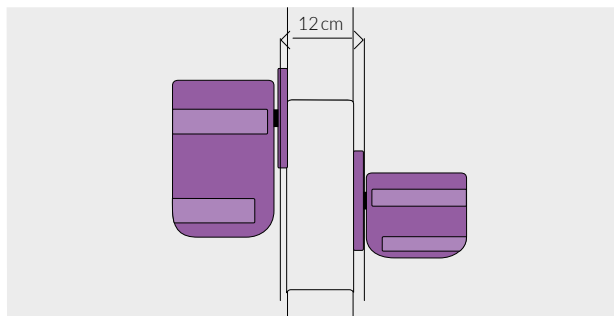

The pedal axle of the leg trainer is steplessly height adjustable from 26 to 46 cm (measured from floor).



The child-friendly pedal distance of 12 cm avoids misalignment of the hip joint.

Series and special colours

Designation	Order No.
 Special colour yellow (RAL 1028 frame cream white)	526.000
 Special colour red (RAL 3000 frame cream white)	525.000
 Special colour green (RAL 6001 frame cream white)	527.000
Other colours according to RAL colour scale	528.000

MOTomed® gracile12

Leg or arm/upper body trainer



Order number: 594.003 + 599.000

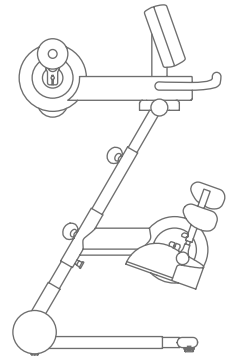

Basic equipment (For all details, see equipment and functions, [page 23](#))

Pediatric safety foot shells (pair, incl. pedal cranks)

Pediatric leg guides with calf shells (pair)

Soft Grip handles (pair, incl. pedal cranks)

Technical data

Dimensions (L×W×H):	60–88 × 55 × 99–114 cm
Weight:	33 kg
Maximum patient weight:	90 kg
Display size:	5.7" / 14.5 cm
Classification:	Ila according to MDD 93/42/EEC
Mains voltage: 100–240 V~ / max. 120 VA, mains frequency: 47–63Hz, class II equipment / Type BF	

Frequently used accessories (More accessories from [page 40](#) onwards)

Designation	Order No.	Page
Plastic-coated pediatric safety foot shells (pair, incl. pedal cranks)	152.120	p. 44 ⓘ
Pediatric leg guides with plastic-coated calf shells (pair)	170.100	p. 45 ⓘ
Pedal radius quick adjustment for pediatric safety foot shells (leg trainer, pair)	588.020	p. 46 ⓘ
Self-operated foot holders (pair)	598.000	p. 45 ⓘ
Pediatric forearm shells with arm cuffs, size S (pair)	556.024	p. 52 ⓘ
Hand fixation by wrist cuff, size S (piece)	562.020	p. 48 ⓘ
Pediatric tetra handles (pair)	555.020	p. 50 ⓘ
Vertical handles with hand rests for children (pair)	557.020	p. 51 ⓘ
Wheelchair stabilizer for children	100.020	p. 54 ⓘ

MOTomed® gracile12

Leg trainer



Order number: 594.003

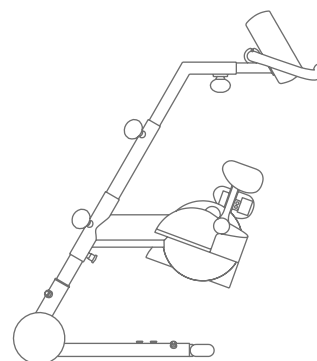

Basic equipment (For all details, see equipment and functions, [page 23](#))

Pediatric safety foot shells (pair, incl. pedal cranks)

Pediatric leg guides with calf shells (pair)

Technical data

Dimensions (L×W×H):	68-85 × 55 × 76-106 cm
Weight:	25 kg
Maximum patient weight:	90 kg
Display size:	5,7" / 14,5 cm
Classification:	Ila according to MDD 93/42/EEC
Mains voltage: 100-240 V~ / max. 120 VA, mains frequency: 47-63Hz, class II equipment / Type BF	

Frequently used accessories (More accessories from [page 40](#) onwards)

Designation	Order No.	Page
Plastic-coated pediatric safety foot shells (pair, incl. pedal cranks)	152.120	p. 44 ⓘ
Pediatric leg guides with plastic-coated calf shells (pair)	170.100	p. 45 ⓘ
Pedal radius quick adjustment for pediatric safety foot shells (leg trainer, pair)	588.020	p. 46 ⓘ
Self-operated foot holders (pair)	598.000	p. 45 ⓘ
Safety foot shells for adults, gracile12 (pair, incl. pedal cranks)*	586.100	p. 44 ⓘ
Flat stand (flat steel)	587.100	p. 55 ⓘ

*Only available in combination with flat stand (order no. 587.100)



MOTomed® LAYSON



Simple operation and modern hygiene management

MOTomed layson is flexible and easy to move thanks to free rolling casters. The high-quality material of the softly rounded surfaces also meets the high requirements of hygiene management in rehabilitation facilities and clinics.



Non-binding illustration of MOTomed layson.la (expandable chassis)

MOTomed® layson Edition

The new generation of movement therapy in supine position: MOTomed layson offers motor-assisted and active training of legs or arms with impressively intuitive and easy operation. The height of the MOTomed layson can be adjusted steplessly without effort by means of a gas spring. It can be easily and comfortably driven and can be individually adjusted in just a few simple steps. The orange control elements have an intuitive calling character. The reduction to just a few operating elements enables fast and effective handling in everyday clinical routine.

Two chassis types available

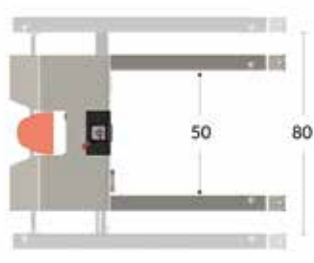

Parallel chassis

By moving the rails parallel (manually with Allen key), the width of the chassis can be adjusted to different requirements. Suitable for one single adjustment.

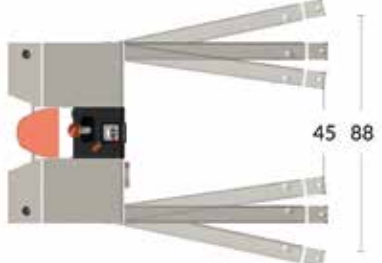

Expandable chassis

The two chassis rails can be spread (by using a lever) to enable quick and tool-free adaptation to different applications. Suitable for multiple daily adjustments.

Basic equipment

- Gas spring support for height adjustment
- Selectable parallel chassis or expandable chassis with ground fixation
- Knee bending adjustment incl. adjustment wheel*¹
- Manual horizontal adjustment
- Colour touch display (7"), rotatable, inclinable*²
- Quick release system for foot shells and handles*¹
- Pedal radius: 7 cm
- Sturdy metal construction, high quality and stable
- Closed plastic body (PC/ABS), easy to clean and disinfect
- Easily movable with large castors (Ø 7.5 cm)
- Serial interface, USB interface
- Plastic-coated transport handle
- Patient remote control*²
- Colour: white/chrome/black/orange

















*¹ Basic equipment of the MOTomed layson leg or arm/upper body trainer

*² Basic equipment with fixed operating panel

Functions

- Passive, Assistive and Active Training
- Electronic foot insertion aid
- Speed from 1 to 60 rpm (passive)
- Brake intensity from 0 to 20 (active)
- Motor power from 1 to 10 (passive)
- Presetting of therapy time from 0 to 120 minutes
- MovementProtection & SpasmControl
- Safety stop
- SymmetryTraining
- Quiet, gentle and harmonious cycle movement (SmoothDriveSystem)
- Gentle starting and stopping of the movement
- Therapy and motivation programs
- Detailed biofeedback during and after training
- Export of training data, import of your own training programs
- Games
- Slideshow via USB (delivered without USB stick)
- Language selection

MOTOmed® layson model overview

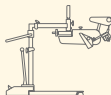
	Order No.	Description/Designation	Page
	261.130	 MOTOmed layson.la Leg or arm/upper body trainer (expandable chassis)	29
	261.030	 MOTOmed layson.la Leg or arm/upper body trainer (parallel chassis)	30
	261.110	 MOTOmed layson.l Leg trainer (expandable chassis)	31
	261.010	 MOTOmed layson.l Leg trainer (parallel chassis)	32
	261.330	 MOTOmed layson kidz.la Leg or arm/upper body trainer (expandable chassis)	33
	261.230	 MOTOmed layson kidz.la Leg or arm/upper body trainer (parallel chassis)	34
	261.310	 MOTOmed layson kidz.l Leg trainer (expandable chassis)	35
	261.210	 MOTOmed layson kidz.l Leg trainer (parallel chassis)	36
	261.119	 MOTOmed layson.l dia Leg trainer (expandable chassis)	37
	261.139	 MOTOmed layson.la prof Leg or arm/upper body trainer (expandable chassis)	39

MOTomed® layson.la (expandable chassis)

Leg or arm/upper body trainer



Order number: 261.130

Price on request

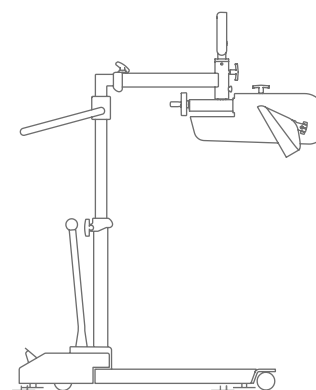

Basic equipment (For all details, see equipment and functions [page 27](#))

Plastic-coated safety foot shells with disinfectable fastening straps and quick release system

(pair, incl. pedal cranks)

Plastic-coated handles with quick release system (pair)

Knee bending adjustment incl. adjustment wheel

Technical data

Dimensions (L×W×H):	134-161 × 62-100 × 118-166 cm
Weight:	86 kg
Height adjustment (max. bed height):	108 cm
Chassis height (ground clearance height):	10 cm
Maximum patient weight:	135 kg
Display size:	7" / 18 cm
Classification:	Ila according to MDD 93/42/EEC
Mains voltage: 100-240 V~ / max. 120 VA, mains frequency: 47-63Hz, class II equipment / Type BF	

Optional product configuration (cannot be changed later)

Designation	Order No.	Page
Removable operating panel	261.520	p. 57 ⓘ

Frequently used accessories (More accessories from [page 40](#) onwards)

»QuickFix« foot fastening system (pair)	265.004	p. 46 ⓘ
Hand fixation by wrist cuff (piece)	562.000	p. 48 ⓘ
Plastic-coated forearm shells with disinfectable fastening straps and quick release system (pair)	356.200	p. 52 ⓘ
»TrainCare« with plastic-coated leg guides	261.500	p. 47 ⓘ
Patient remote control*	261.522	p. 54 ⓘ

* Basic equipment with fixed operating panel

MOTomed® layson.la (parallel chassis)

Leg or arm/upper body trainer



Order number: 261.030

Price on request

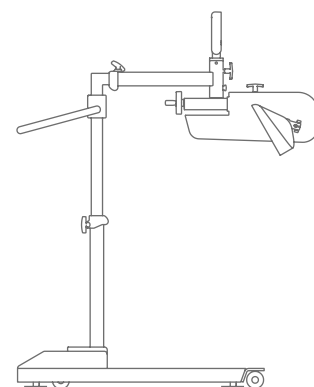

Basic equipment (For all details, see equipment and functions [page 27](#))

Plastic-coated safety foot shells with disinfected fastening straps and quick release system

(pair, incl. pedal cranks)

Plastic-coated handles with quick release system (pair)

Knee bending adjustment incl. adjustment wheel

Technical data

Dimensions (L×W×H):	134–161 × 62–92 × 118–166 cm
Weight:	86 kg
Height adjustment (max. bed height):	108 cm
Chassis height (ground clearance height):	10 cm
Maximum patient weight:	135 kg
Display size:	7" / 18 cm
Classification:	Ila according to MDD 93/42/EEC
Mains voltage: 100–240 V~ / max. 120 VA, mains frequency: 47–63Hz, class II equipment / Type BF	

Optional product configuration (cannot be changed later)

Designation	Order No.	Page
Removable operating panel	261.520	p. 57 ⓘ

Frequently used accessories (More accessories from [page 40](#) onwards)

»QuickFix« foot fastening system (pair)	265.004	p. 46 ⓘ
Hand fixation by wrist cuff (piece)	562.000	p. 48 ⓘ
Plastic-coated forearm shells with disinfected fastening straps and quick release system (pair)	356.200	p. 52 ⓘ
»TrainCare« with plastic-coated leg guides	261.500	p. 47 ⓘ
Patient remote control*	261.522	p. 54 ⓘ

* Basic equipment with fixed operating panel

MOTomed® layson.l (expandable chassis)

Leg trainer

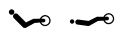

Order number: 261.110

Price on request

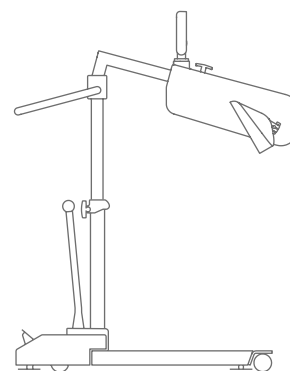

Basic equipment (For all details, see equipment and functions [page 27](#))

Plastic-coated safety foot shells with disinfectable fastening straps (pair, incl. pedal cranks)

Technical data

Dimensions (L×W×H):	101-123 × 62-100 × 109-163 cm
Weight:	79 kg
Height adjustment (max. bed height):	105 cm
Chassis height (ground clearance height):	10 cm
Maximum patient weight:	135 kg
Display size:	7" / 18 cm
Classification:	Ila according to MDD 93/42/EEC

Mains voltage: 100-240 V~ / max. 120 VA, mains frequency: 47-63Hz, class II equipment / Type BF

Optional product configuration (cannot be changed later)

Designation	Order No.	Page
Knee bending adjustment incl. adjustment wheel	261.501	p. 57 ⓘ
Removable operating panel	261.520	p. 57 ⓘ

Frequently used accessories (More accessories from [page 40](#) onwards)

»QuickFix« foot fastening system (pair)	265.004	p. 46 ⓘ
»TrainCare« with plastic-coated leg guides	261.500	p. 47 ⓘ
Patient remote control*	261.522	p. 54 ⓘ

* Basic equipment with fixed operating panel

MOTomed® layson.I (parallel chassis)

Leg trainer

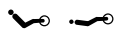

Order number: 261.010

Price on request

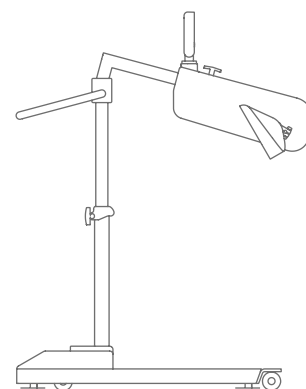

Basic equipment (For all details, see equipment and functions [page 27](#))

Plastic-coated safety foot shells with disinfectable fastening straps (pair, incl. pedal cranks)

Technical data

Dimensions (L×W×H):	101-123 × 62-92 × 109-163 cm
Weight:	79 kg
Height adjustment (max. bed height):	105 cm
Chassis height (ground clearance height):	10 cm
Maximum patient weight:	135 kg
Display size:	7" / 18 cm
Classification:	Ila according to MDD 93/42/EEC
Mains voltage: 100-240 V~ / max. 120 VA, mains frequency: 47-63Hz, class II equipment / Type BF	

Optional product configuration (cannot be changed later)

Designation	Order No.	Page
Knee bending adjustment incl. adjustment wheel	261.501	p. 57 ⓘ
Removable operating panel	261.520	p. 57 ⓘ

Frequently used accessories (More accessories from [page 40](#) onwards)

»QuickFix« foot fastening system (pair)	265.004	p. 46 ⓘ
»TrainCare« with plastic-coated leg guides	261.500	p. 47 ⓘ
Patient remote control*	261.522	p. 54 ⓘ

* Basic equipment with fixed operating panel

MOTomed® layson kidz.la (expandable chassis)

Leg or arm/upper body trainer



Order number: 261.330

Price on request

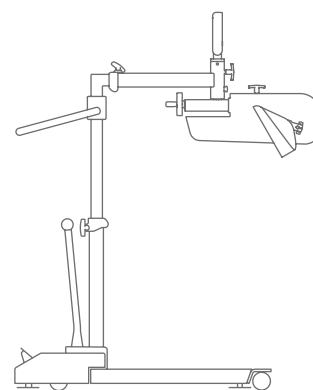

Basic equipment (For all details, see equipment and functions [page 27](#))

Plastic-coated pediatric safety foot shells with disinfectable fastening straps and quick release system (pair, incl. pedal cranks)

Plastic-coated pediatric handles with quick release system (pair)

Knee bending adjustment incl. adjustment wheel

Technical data

Dimensions (L×W×H):	134-161 × 62-100 × 118-166 cm
Weight:	86 kg
Height adjustment (max. bed height):	108 cm
Chassis height (ground clearance height):	10 cm
Maximum patient weight:	135 kg
Display size:	7" / 18 cm
Classification:	Ila according to MDD 93/42/EEC
Mains voltage: 100-240 V~ / max. 120 VA, mains frequency: 47-63Hz, class II equipment / Type BF	

Optional product configuration (cannot be changed later)

Designation	Order No.	Page
Removable operating panel	261.520	p. 57 ⓘ

Frequently used accessories (More accessories from [page 40](#) onwards)

Hand fixation by wrist cuff, size S (piece)	562.020	p. 48 ⓘ
»TrainCare kidz« with plastic-coated pediatric leg guides	261.502	p. 47 ⓘ
Patient remote control*	261.522	p. 54 ⓘ

* Basic equipment with fixed operating panel

MOTomed® layson kidz.la (parallel chassis)

Leg or arm/upper body trainer



Order number: 261.230

Price on request

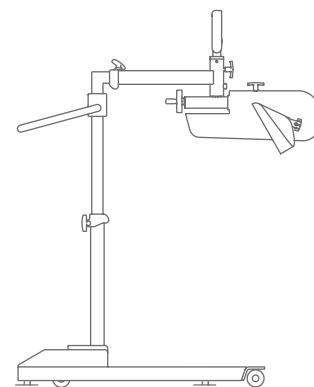

Basic equipment (For all details, see equipment and functions [page 27](#))

Plastic-coated pediatric safety foot shells with disinfectable fastening straps and quick release system

(pair, incl. pedal cranks)

Plastic-coated pediatric handles with quick release system (pair)

Knee bending adjustment incl. adjustment wheel

Technical data

Dimensions (L×W×H):	134–161 × 62–92 × 118–166 cm
Weight:	86 kg
Height adjustment (max. bed height):	108 cm
Chassis height (ground clearance height):	10 cm
Maximum patient weight:	135 kg
Display size:	7" / 18 cm
Classification:	Ila according to MDD 93/42/EEC
Mains voltage: 100–240 V~ / max. 120 VA, mains frequency: 47–63Hz, class II equipment / Type BF	

Optional product configuration (cannot be changed later)

Designation	Order No.	Page
Removable operating panel	261.520	p. 57 ⓘ

Frequently used accessories (More accessories from [page 40](#) onwards)

Hand fixation by wrist cuff, size S (piece)	562.020	p. 48 ⓘ
»TrainCare kidz« with plastic-coated pediatric leg guides	261.502	p. 47 ⓘ
Patient remote control*	261.522	p. 54 ⓘ

* Basic equipment with fixed operating panel

MOTomed® layson kidz.I (expandable chassis)

Leg trainer

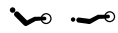

Order number: 261.310

Price on request

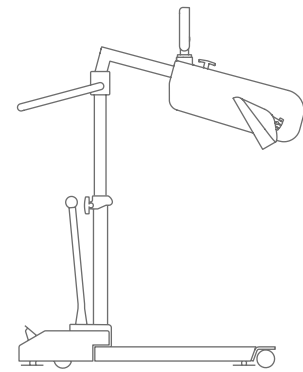

Basic equipment (For all details, see equipment and functions, [page 27](#))

Plastic-coated pediatric safety foot shells with disinfectable fastening straps (pair, incl. pedal cranks)

Technical data

Dimensions (L×W×H):	101-123 × 62-100 × 109-163 cm
Weight:	79 kg
Height adjustment (max. bed height):	105 cm
Chassis height (ground clearance height):	10 cm
Maximum patient weight:	135 kg
Display size:	7" / 18 cm
Classification:	Ila according to MDD 93/42/EEC
Mains voltage: 100-240 V~ / max. 120 VA, mains frequency: 47-63Hz, class II equipment / Type BF	

Optional product configuration (cannot be changed later)

Designation	Order No.	Page
Knee bending adjustment incl. adjustment wheel	261.501	p. 57 ⓘ
Removable operating panel	261.520	p. 57 ⓘ

Frequently used accessories (More accessories from [page 40](#) onwards)

»TrainCare kidz« with plastic-coated pediatric leg guides	261.502	p. 47 ⓘ
Patient remote control*	261.522	p. 54 ⓘ

* Basic equipment with fixed operating panel

MOTomed® layson kidz.I (parallel chassis)

Leg trainer

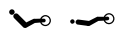

Order number: 261.210

Price on request

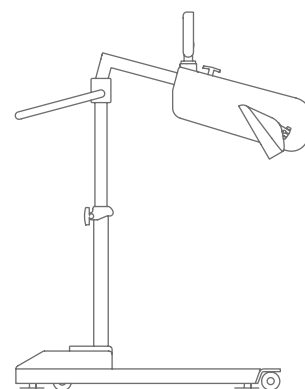

Basic equipment (For all details, see equipment and functions, [page 27](#))

Plastic-coated pediatric safety foot shells with disinfectable fastening straps (pair, incl. pedal cranks)

Technical data

Dimensions (L×W×H):	101-123 × 62-92 × 109-163 cm
Weight:	79 kg
Height adjustment (max. bed height):	105 cm
Chassis height (ground clearance height):	10 cm
Maximum patient weight:	135 kg
Display size:	7" / 18 cm
Classification:	Ila according to MDD 93/42/EEC
Mains voltage: 100-240 V~ / max. 120 VA, mains frequency: 47-63Hz, class II equipment / Type BF	

Optional product configuration (cannot be changed later)

Designation	Order No.	Page
Knee bending adjustment incl. adjustment wheel	261.501	p. 57 ⓘ
Removable operating panel	261.520	p. 57 ⓘ

Frequently used accessories (More accessories from [page 40](#) onwards)

»TrainCare kidz« with plastic-coated pediatric leg guides	261.502	p. 47 ⓘ
Patient remote control*	261.522	p. 54 ⓘ

* Basic equipment with fixed operating panel

MOTomed® layson.l dia (expandable chassis)

Leg trainer specially designed for dialysis treatment

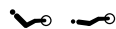
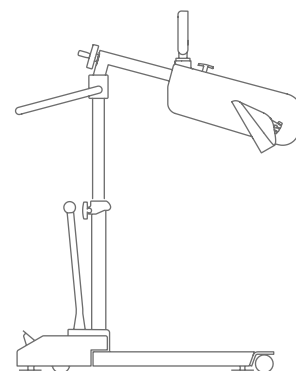

Order number: 261.119

Price on request

Basic equipment (For all details, see equipment and functions, [page 27](#))

Plastic-coated safety foot shells with disinfectable fastening straps (pair, incl. pedal cranks)

Knee bending adjustment incl. adjustment wheel

Removable operating panel

Technical data

Dimensions (L×W×H):	101-123 × 62-100 × 109-163 cm
Weight:	80 kg
Height adjustment (max. bed height):	105 cm
Chassis height (ground clearance height):	10 cm
Maximum patient weight:	135 kg
Display size:	7" / 18 cm
Classification:	Ila according to MDD 93/42/EEC

Mains voltage: 100-240 V~ / max. 120 VA, mains frequency: 47-63Hz, class II equipment / Type BF

Frequently used accessories (More accessories from [page 40](#) onwards)

Designation	Order No.	Page
»QuickFix« foot fastening system (pair)	265.004	p. 46 ⓘ
»TrainCare« with plastic-coated leg guides	261.500	p. 47 ⓘ
Patient remote control	261.522	p. 54 ⓘ

MOTomed[®] PROFESSIONAL SERIES



For clinics and rehabilitation facilities

The MOTomed Professional Series are tailor-made devices for versatile use in clinics and rehabilitation facilities.

MOTomed layson.la prof includes the following special features:

- ❶ Plastic-coated safety foot shells with quick release system
- ❷ »TrainCare« with plastic-coated leg guides and disinfectable fastening straps
- ❸ »QuickFix« foot fastening system
- ❹ Knee bending adjustment incl. adjustment wheel
- ❺ Plastic-coated handles with quick release system
- ❻ Removable operating panel
- ❼ Patient remote control



Non-binding illustration of MOTomed layson.la prof

MOTomed® layson.la prof (expandable chassis)

Leg or arm/upper body trainer



Order number: 261.139

Price on request

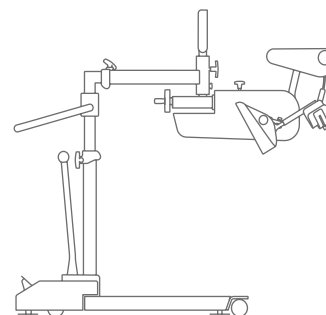

Basic equipment (For all details, see equipment and functions, [page 27](#))

Plastic-coated safety foot shells with quick release system (pair, incl. pedal cranks)

»TrainCare« with plastic-coated leg guides and disinfectable fastening straps

»QuickFix« foot fastening system (pair)

Knee bending adjustment incl. adjustment wheel

Plastic-coated handles with quick release system (pair)

Removable operating panel

Patient remote control

Technical data

Dimensions (L×W×H):	151-178 × 62-100 × 118-166 cm
Weight:	92 kg
Height adjustment (max. bed height):	108 cm
Chassis height (ground clearance height):	10 cm
Maximum patient weight:	135 kg
Display size:	7" / 18 cm
Classification:	Ila according to MDD 93/42/EEC
Mains voltage: 100-240 V~ / max. 120 VA, mains frequency: 47-63Hz, class II equipment / Type BF	

Frequently used accessories (More accessories from [page 40](#) onwards)

Designation	Order No.	Page
Hand fixation by wrist cuff (piece)	562.000	p. 48 ⓘ
Plastic-coated forearm shells with disinfectable fastening straps and quick release system (pair)	356.200	p. 52 ⓘ
Docking station for removable operating panel	261.523	p. 54 ⓘ



MOTomed®
ACCESSORIES



MOTomed® accessories

Leg trainer accessories

○ Basic equipment ● Accessories ◐ Model-dependent equipment

		muvi	loop	gracile12	layson
 <p>265.400 Soft Grip safety foot shells with fastening straps (pair, incl. pedal cranks)</p> <ul style="list-style-type: none"> • Sturdy metal foot shells, softly padded and non-slip • High safety edge to the pedal bar • Fixation of the feet by means of fastening straps in the ankle joint area (on request also in the toe area) • Two-stage pedal radius 7.0 cm and 12.5 cm adjustable <p>◐ loop ○ loop light ● loop parkinson ● loop kidz ● loop prof</p>			◐		
 <p>265.421 Plastic-coated safety foot shells with fixation by fastening straps (pair, incl. pedal cranks)</p> <ul style="list-style-type: none"> • Stable metal foot shells coated with disinfectable soft PVC • Recommended for use in rehabilitation facilities • High safety edge to the pedal bar • Fixation of the feet by means of fastening straps • Two-stage pedal radius 7.0 cm and 12.5 cm adjustable <p>○ loop ● loop light ○ loop parkinson ○ loop kidz ○ loop prof</p>			◐		
 <p>265.440 Plastic-coated safety foot shells with disinfectable fastening straps (pair)</p> <ul style="list-style-type: none"> • Stable metal foot shells coated with disinfectable soft PVC • Recommended for use in rehabilitation facilities • High safety edge to the pedal bar • Fixation of the feet by means of disinfectable fastening straps • Two-stage pedal radius 7.0 cm and 12.5 cm adjustable 		●			

○ Basic equipment ● Accessories ○ Model-dependent equipment

muvi	loop	gracile12	layson
------	------	-----------	--------



265.441

Plastic-coated safety foot shells with disinfectable fastening straps (pair, incl. pedal cranks)

- Stable metal foot shells coated with disinfectable soft PVC
- Recommended for use in rehabilitation facilities
- High safety edge to the pedal bar
- Fixation of the feet by means of disinfectable fastening straps
- Two-stage pedal radius 7.0 cm and 12.5 cm adjustable



- loop ● loop light ● loop parkinson ● loop kidz ● loop prof

●



261.440

Plastic-coated safety foot shells with disinfectable fastening straps (pair, incl. pedal cranks, with external rotation)

- Stable metal foot shells coated with disinfectable soft PVC
- Recommended for use in rehabilitation facilities
- High safety edge to the pedal bar
- Fixation of the feet by means of disinfectable fastening straps

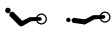

- layson (.l) ● layson (.la) ● layson kidz ○ layson dia ● layson prof

Price on request

261.460

Plastic-coated safety foot shells with disinfectable fastening straps and quick release system (pair, incl. pedal cranks, with external rotation)

- layson (.l) ○ layson (.la) ● layson kidz ● layson dia ○ layson prof

Price on request

○

○

○ Basic equipment ● Accessories ◐ Model-dependent equipment



265.460
Plastic-coated pediatric safety foot shells with fixation by fastening straps (pair, incl. pedal cranks)

- Stable metal foot shells coated with disinfectable soft PVC
- Recommended for use in rehabilitation facilities
- High safety edge to the pedal bar
- Fixation of the feet by means of fastening straps
- Foot shell inside 8.8 cm wide and 20.6 cm long
- Two-stage pedal radius 7.0 cm and 12.5 cm adjustable
- Specially designed for children



265.480
Plastic-coated pediatric safety foot shells with disinfectable fastening straps (pair, incl. pedal cranks)

- Stable metal foot shells coated with disinfectable soft PVC
- Recommended for use in rehabilitation facilities
- High safety edge to the pedal bar
- Fixation of the feet by means of disinfectable fastening straps
- Foot shell inside 8.8 cm wide and 20.6 cm long
- Two-stage pedal radius 7.0 cm and 12.5 cm adjustable
- Specially designed for children

261.480
Plastic-coated pediatric safety foot shells with disinfectable fastening straps (pair, incl. pedal cranks, with external rotation)

● layson ○ layson kidz (.l) ● layson kidz (.la) ● layson dia ● layson prof

Price on request

261.490
Plastic-coated pediatric safety foot shells with disinfectable fastening straps and quick release system (pair, incl. pedal cranks, with external rotation)

● layson ● layson kidz (.l) ○ layson kidz (.la) ● layson dia ● layson prof

Price on request

muvi	loop	gracile12	layson
	●		
	●		
			◐
			◐

MUVI

LOOP

GRACILE12

LAYSON

ACCESSORIES

UPGRADES

○ Basic equipment ● Accessories ○ Model-dependent equipment

muvi	loop	gracile12	layson
------	------	-----------	--------



152.120
Plastic-coated pediatric safety foot shells
(pair, incl. pedal cranks)

- Sturdy metal foot shells, padded and slip-proof
- comfortable fixation of the feet with fastening straps
- Foot shell 10.1 cm wide and 21.7 cm long with open side rim
- Pedal radius adjustable 2-fold (3.5 cm and 7.0 cm)
- Recommended for use in rehabilitation facilities
- Easy to disinfect

●



586.100
Safety foot shells for adults, gracile12
(pair, incl. pedal cranks)

- Sturdy metal foot shells, padded and slip-proof
- Comfortable fixation of the feet with fastening straps
- Only possible in combination with flat stand (order no. 587.100)

●



302.000
Leg guides with calf shells (pair)*

- For secure support and guidance of the legs
- Spring-loaded calf shells nestle elastically to the body
- Comfortable fixation by means of fastening straps
- Articulated and height-adjustable (9.0 cm to 16.0 cm)
- Removable calf shells, fold-down guide rail (lower part)

● loop ● loop light ● loop parkinson ● loop kidz ● loop prof

●

* Only available in combination with Soft Grip safety foot shells (order no. 265.400)

○ Basic equipment ● Accessories ◐ Model-dependent equipment

		muvi	loop	gracile12	layson
	<p>303.000</p> <p>Leg guides with plastic-coated calf shells and fastening straps (pair)</p> <ul style="list-style-type: none"> • Articulated and height-adjustable • Recommended for use in rehabilitation facilities 	●	●		
	<p>186.000</p> <p>Leg guides with plastic-coated calf shells (pair) and disinfectable fastening straps</p> <ul style="list-style-type: none"> • Recommended for use in rehabilitation facilities • Easy to disinfect <p>● muvi ● loop ● loop light ● loop parkinson ● loop kidz ○ loop prof</p>	●	◐		
	<p>170.100</p> <p>Leg guides with plastic-coated calf shells and fastening straps (pair)</p> <ul style="list-style-type: none"> • Recommended for use in rehabilitation facilities • Easy to disinfect <p>● loop kidz* ● gracile12</p>		●	●	
	<p>598.000</p> <p>Self-operated foot holders (pair)</p> <ul style="list-style-type: none"> • Soft foam rollers fix the feet gently and safely • Firm hold even with strong spasticity due to the safety locking device • For quick mounting and dismounting 			●	

* Only available in combination with pediatric safety foot shells (order no. 265.460 and 265.480)

○ Basic equipment ● Accessories ◐ Model-dependent equipment

muvi	loop	gracile12	layson
------	------	-----------	--------



265.004

»QuickFix« foot fastening system (pair)

- For quick fixation and release of the feet
- Paddings are easy to clean and disinfect

- muvi ● loop ● loop light ● loop parkinson ● loop kidz ○ loop prof
- layson ● layson kidz ● layson dia ○ layson prof



●	◐		◐
---	---	--	---



507.020

Pedal radius quick adjustment (leg trainer, pair)

- Incl. plastic-coated safety foot shells
- Steplessly or precisely adjustable in 4 steps (5.0 / 7.5 / 10.0 / 12.5 cm)
- Recommended for joint stiffness (contractures) and severe spasticity



305.000

Pedal radius quick adjustment (leg trainer, pair)

Price on request

	◐		
--	---	--	--

●			
---	--	--	--



588.020

Pedal radius quick adjustment for pediatric safety foot shells (leg trainer, pair)

- Incl. Pediatric safety foot shells
- For precise adjustment of the pedal radius
- Stepless or adjustable in 3 steps (5.5 / 8.0 / 10.5 cm)
- Recommended for joint stiffness (contractures) and severe spasticity
- The attachment widens the inner distance of the foot shells by 3.5 cm



		●	
--	--	---	--

○ Basic equipment ● Accessories ◐ Model-dependent equipment

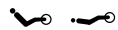

261.500

»TrainCare« with plastic-coated leg guides and disinfectable fastening straps

- For a secure hold and guidance of the legs, prevents unintentional lateral movement
- Prevents overstretching or blocking of the knee joints
- Knee relief individually adjustable on both sides
- With plastic-coated calf shells (can be disinfected) and disinfectable expanders
- Fixation by means of disinfectable fastening straps

● layson ● layson dia ○ layson prof

Price on request



261.502

»TrainCare kidz« with plastic-coated pediatric leg guides and disinfectable fastening straps*

● layson kidz





Price on request

muvi	loop	gracile12	layson
			◐
			●







* Only available in combination with Pediatric safety foot shells (order no. 261.480 and 261.490)

Arm trainer accessories

○ Basic equipment ● Accessories ● Model-dependent equipment

		muvi	loop	gracile12	layson
	<p>507.050 Pedal radius quick adjustment (arm trainer, pair)</p> <ul style="list-style-type: none"> • For precise adjustment of the pedal radius • Steplessly or precisely adjustable in 4 steps (5.0 / 7.5 / 10.0 / 12.5 cm) • Recommended for joint stiffness (contractures) and severe spasticity 	●			
	<p>588.050 Pedal radius quick adjustment for children (arm trainer, pair)</p> <p>Price on request</p>			●	
	<p>599.100 Arm/upper body trainer active and passive (retrofit kit)</p> <ul style="list-style-type: none"> • Incl. swiveling handle bar for leg training • Can be swiveled into the training area for maximum legroom during arm/upper body training • Incl. symmetry training and motivation programs • Height adjustable without tools for an ideal training position • Pedal radius adjustable 2-fold (3.5 cm and 7.0 cm) 			●	
	<p>562.000 Hand fixation by wrist cuff, size L (piece)</p> <ul style="list-style-type: none"> • Easy and quick fixation of the paralyzed (weak) hand on the arm/upper body trainer, on handle or the various hand grips • Recommended for users with limited gripping function 	●	●	●	●
	<p>562.030 Hand fixation by wrist cuff, size M (piece)</p>	●	●	●	●
	<p>562.020 Hand fixation by wrist cuff, size S (piece)</p>	●	●	●	●

○ Basic equipment ● Accessories ◐ Model-dependent equipment

		muvi	loop	gracile12	layson
 <p>265.100 Soft Grip handles (pair)</p> <ul style="list-style-type: none"> Sturdy handles, soft padded and non-slip <p>○ loop ○ loop light ○ loop parkinson ○ loop kidz ● loop prof</p>			◐		
	 <p>265.110 Soft Grip handles with quick release system (pair)</p>		●		
 <p>265.120 Plastic-coated handles with quick release system (pair)</p> <ul style="list-style-type: none"> Stable handles coated with disinfectable soft PVC Easy to disinfect, recommended for use in rehabilitation facilities <p>○ muvi ● loop ● loop light ● loop parkinson ● loop kidz ○ loop prof</p>		●	◐		
	 <p>261.524 Plastic-coated handles with quick release system (pair)</p> <ul style="list-style-type: none"> Extended arm handle specially designed for lying patients <p>○ layson.la ● layson kidz.la ○ layson prof</p> <p>Price on request</p>				◐

MUVI

LOOP

GRACILE12

LAYSON

ACCESSORIES

UPGRADES

○ Basic equipment ● Accessories ◐ Model-dependent equipment

muvi
loop
gracile12
layson

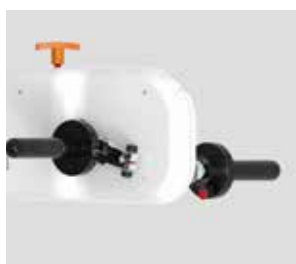

261.525
Plastic-coated pediatric handles with quick release system (pair)

- Extended arm handle specially designed for children in supine position

● layson.la ○ layson kidz.la ● layson prof



Price on request

◐



555.000
Tetra handles (pair)

- For easy and independent insertion of the arms
- With forearm support, which can be adjusted flexibly
- Especially suitable for tetraplegics and partly for stroke patients



555.200
Tetra handles with quick release system (pair)

●

●

●

●





555.020
Pediatric tetra handles (pair)

- For easy and independent insertion of the arms
- With forearm support, which can be adjusted flexibly
- Especially suitable for tetraplegics and partly for stroke patients



●

○ Basic equipment ● Accessories ◐ Model-dependent equipment

		muvi	loop	gracile12	layson
	<p>557.001 Vertical handles with hand rests (pair)</p> <ul style="list-style-type: none"> • For users who can hold on to something but require a hand rest • With slip protection on the inside 		●		
	<p>557.201 Vertical handles with hand rests and quick release system (pair)</p>	●	●		●
	<p>557.020 Pediatric vertical handles with hand rests (pair)</p> <ul style="list-style-type: none"> • For users who can hold on to something but require a hand rest • With slip protection on the inside 			●	
	<p>372.000 Plastic-coated ergo handles (pair)</p> <ul style="list-style-type: none"> • User can choose from 3 handle holding positions • Enables an individual hand position without equipment change • Recommended for use in rehabilitation facilities • Easy to disinfect 		●		
	<p>372.200 Plastic-coated ergo handles with quick release system (pair)</p>	●	●		●



MUVI

LOOP

GRACILE12

LAYSON

ACCESSORIES

UPGRADES

○ Basic equipment ● Accessories ◐ Model-dependent equipment

muvi	loop	gracile12	layson
------	------	-----------	--------



567.001

Plastic-coated hook grip (piece)

- Easy and quick fixation of paralyzed (weak) hand on the arm trainer or handle
- Recommended for users with limited gripping function



●	●		●
---	---	--	---

567.021

Pediatric plastic-coated hook grip (piece)

		●	
--	--	---	--



356.200

Plastic-coated forearm shells with disinfectable fastening straps and quick release system (pair)

- Ergonomically shaped and padded, 28.0 cm long
- For fastening and guiding the arms in case of severe paralysis
- Lateral evasive movement of the forearms is possible
- Recommended for use in rehabilitation facilities (easy to disinfect)



●	●		●
---	---	--	---



556.024

Pediatric forearm shells with arm cuffs, size S (pair)

- Arm fixation and guidance in case of severe paralysis
- Lateral evasive movement of the forearms is possible
- Ergonomically shaped and padded, 21.0 cm long
- Standard with special cross handle for children
- Cuffs supplied as standard in size S



		●	
--	--	---	--

556.023

Pediatric forearm shells with arm cuffs, size XS (pair)

		●	
--	--	---	--

○ Basic equipment

● Accessories

◐ Model-dependent equipment



556.006

Forearm shells with arm cuffs, size L (pair)

- Ergonomically shaped and padded, 28.0 cm long
- For fastening and guiding the arms in case of severe paralysis
- Lateral evasive movement of the forearms is possible
- With cross handle as standard
- Cuffs supplied as standard in size L

556.003

Forearm shells with arm cuffs, size XS (pair)

556.004

Forearm shells with arm cuffs, size S (pair)

556.005

Forearm shells with arm cuffs, size M (pair)

556.007

Forearm shells with arm cuffs, size XL (pair)

muvi	loop	gracile12	layson
	●		
	●		
	●		
	●		
	●		

MUVI

LOOP







GRACILE12

LAYSON

ACCESSORIES





UPGRADES

Other accessories

○ Basic equipment	● Accessories	◐ Model-dependent equipment		muvi	loop	gracile12	layson
 <p>261.522 Patient remote control*</p> <ul style="list-style-type: none"> • The user can stop and restart the training while lying down • Cable length approx. 2.9 m <p>● layson ● layson kidz ● layson dia ○ layson prof</p> <p>Price on request</p> 						◐	
 <p>261.523 Docking station for removable operating panel</p> <ul style="list-style-type: none"> • Holder for attaching the removable operating panel • Plastic-coated for easier disinfection • Magnetic fixation <p>Price on request</p> 						●	
 <p>100.000 Wheelchair stabilizer</p> <ul style="list-style-type: none"> • Recommended for severe spasticity • Supports the wheelchair: prevents tipping and slipping backwards • For all common wheelchairs with push handle • With padded support for the wheelchair push handles • Width of the handle support: 580 mm 	<p>100.020 Wheelchair stabilizer for children</p> <ul style="list-style-type: none"> • Especially designed for children's wheelchairs with push handle • Width of the handle support: 330 mm 		●	●			

* Basic equipment with fixed operating panel

○ Basic equipment ● Accessories ◐ Model-dependent equipment

		muvi	loop	gracile12	layson
	<p>587.100 Flat stand (flat steel)</p> <ul style="list-style-type: none"> • For easy driving over with sports wheelchairs, electric wheelchairs and wheelchairs with rigid footrest 			●	
	<p>308.100 Belt stabilizer comfort</p> <ul style="list-style-type: none"> • Incl. front stand • Incl. suspension rod and release hook • Easy to operate from a wheelchair without an assistant • Flexible application for different types of wheelchairs 	●			
	<p>265.005 Belt stabilizer</p>		●		
	<p>508.000 Therapy chair</p> <ul style="list-style-type: none"> • Stable chair with 4 large steerable casters • Central brake lever for easy locking • Gas spring supported seat height adjustment (42.0 cm–57.0 cm) • Adjustable armrests (height above the seat: 0.0 cm–24.0 cm; width: 41.0 cm–55.0 cm) • Adjustable angle of inclination of seat and backrest • For persons up to 160 kg body weight <p>Price on request</p>	●	●		

MUVI

LOOP

GRACILE12

LAYSON

ACCESSORIES

UPGRADES











MOTomed®
PRODUCT
CONFIGURATION

MOTomed® product configuration

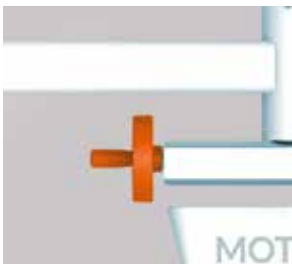
Product configurations **cannot** be retrofitted at a later date.

Basic equipment
 Optional product configuration
 Model-dependent product configuration

		loop	layson
 <p>265.001 Special stand with reduced stand height</p> <ul style="list-style-type: none"> • For easier starting with sports wheelchairs, electric wheelchairs and wheelchairs with rigid footrest • Height of standard stand: 72 mm (mid-foot), Height of special stand: 30 mm 		<input checked="" type="radio"/>	
 <p>265.002 Gas spring support for height adjustment</p> <ul style="list-style-type: none"> • Infinitely height adjustable, no effort required <p> <input checked="" type="radio"/> loop <input checked="" type="radio"/> loop light <input checked="" type="radio"/> loop parkinson <input checked="" type="radio"/> loop kidz <input type="radio"/> loop prof </p> 		<input checked="" type="radio"/>	
 <p>261.501 Knee bending adjustment incl. adjustment wheel</p> <ul style="list-style-type: none"> • To adjust the strength of knee flexion • For setting the ideal position without repositioning the patient • Quick and comfortable adjustment, with inserted legs <p> <input type="radio"/> layson (.la) <input checked="" type="radio"/> layson (.l) <input type="radio"/> layson kidz (.la) <input checked="" type="radio"/> layson kidz (.l) </p> <p> <input type="radio"/> layson dia <input type="radio"/> layson prof </p> <p>Price on request</p> 		<input checked="" type="radio"/>	
 <p>261.520 Removable operating panel</p> <ul style="list-style-type: none"> • The user can operate the MOTomed independently • Cable with rewinder, length of unrolled cable approx. 2.9 m <p> <input checked="" type="radio"/> layson <input checked="" type="radio"/> layson kidz <input type="radio"/> layson dia <input type="radio"/> layson prof </p> <p>Price on request</p> 		<input checked="" type="radio"/>	



MOTomed® UPGRADES



Digital intelligence

To meet new needs, users have a total of **73 upgrades** available to enhance their leg or arm/upper body trainer, arm/upper body trainer and leg trainer. The MOTomed loop can also be adapted to new indications via a software package (e.g. Parkinson's disease).

MOTomed® upgrade bundles

Our motion trainers of the MOTomed loop edition can be adapted with upgraded bundles to meet changed requirements. Thanks to the use of different attachments and software packages, almost every MOTomed loop can be upgraded. All extensions can be found in the [upgrade table on page 60](#), or contact RECK (tel: +49 7374 18-85) or a specialist dealer you trust.

Frequently used MOTomed loop upgrade bundles:



260.211

MOTomed loop.I >>> MOTomed loop.la

Included in the upgrade bundle: software package, Soft Grip handles (pair, incl. pedal cranks)



260.251

MOTomed loop light.la >>> MOTomed loop.la

Included in the upgrade bundle: software package, plastic-coated safety foot shells with fastening straps (pair, incl. pedal cranks)



260.235

MOTomed loop.la >>> MOTomed loop p.la

Included in the upgrade bundle: software package



260.295

MOTomed loop kidz.a >>> MOTomed loop p.la

Included in the upgrade bundle: software package, plastic-coated safety foot shells with fastening straps (pair, incl. pedal cranks)

MOTOmed® loop upgrades

Your model

MOTOmed loop.l		✓ 260.211	✓ 260.212		✓ 260.213		
MOTOmed loop.la	✓ 260.230		✓ 260.232		✓ 260.233		
MOTOmed loop.a	✓ 260.220	✓ 260.221			✓ 260.223		
MOTOmed loop light.l							
MOTOmed loop light.la	✓ 260.250	✓ 260.251	✓ 260.252				
MOTOmed loop light.a							
MOTOmed loop p.l	✓ 260.240	✓ 260.241	✓ 260.242		✓ 260.243		
MOTOmed loop p.la	✓ 260.260	✓ 260.261	✓ 260.262		✓ 260.263		
MOTOmed loop kidz.l	✓ 260.270	✓ 260.271	✓ 260.272		✓ 260.273		
MOTOmed loop kidz.la	✓ 260.280	✓ 260.281	✓ 260.282		✓ 260.283		
MOTOmed loop kidz.a	✓ 260.290	✓ 260.291	✓ 260.292		✓ 260.293		
MOTOmed loop.la prof							
Desired upgrade →	MOTOmed loop.l	MOTOmed loop.la	MOTOmed loop.a	MOTOmed loop light.l	MOTOmed loop light.la	MOTOmed loop light.a	

	✓ 260.214	✓ 260.215	✓ 260.216	✓ 260.217	✓ 260.218
	✓ 260.234	✓ 260.235	✓ 260.236	✓ 260.237	✓ 260.238
	✓ 260.224	✓ 260.225	✓ 260.226	✓ 260.227	✓ 260.228
	✓ 260.254	✓ 260.255	✓ 260.256	✓ 260.257	✓ 260.258
		✓ 260.245	✓ 260.246	✓ 260.247	✓ 260.248
	✓ 260.264		✓ 260.266	✓ 260.267	✓ 260.268
	✓ 260.274	✓ 260.275		✓ 260.277	✓ 260.278
	✓ 260.284	✓ 260.285	✓ 260.286		✓ 260.288
	✓ 260.294	✓ 260.295	✓ 260.296	✓ 260.297	
		✓ 260.239			
	MOTOmed loop p.l	MOTOmed loop p.l.a	MOTOmed loop kidz.l	MOTOmed loop kidz.l.a	MOTOmed loop kidz.a

 Upgrade

For detailed information and pricing on individual upgrade bundles, please contact RECK (Tel: +49 7374 18-85) or your trusted dealer.

MOTOmed Service



Competent advice

The MOTOmed consulting team will do everything in its power to adapt the device to your individual needs to ensure you have the best possible training. In addition, the MOTOmed team will support you in acquiring and applying for a MOTOmed.

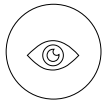

Demonstration

The MOTOmed consulting team will gladly organize a demonstration together with our partner in your country.

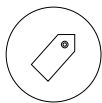

Rent

The MOTOmed consulting team will be pleased to inform you about the different options for purchase or rent. Please contact us for further information. We will be happy to advise you.



Studies

On a scientific level, the effectiveness of MOTOmed movement therapy has been demonstrated in different clinical pictures. You are welcome to take a look at more than 30 studies and scientific research results.



Testimonials

What experiences and successes have patients and facilities had using MOTOmed movement therapy? Give us a call. We will send you reports that are relevant to the corresponding indication free of charge.

Inform yourself – www.motomed.com

**MADE
IN
GERMANY**

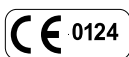

We constantly adapt our products to the latest state of the art in science and technology. Therefore, there may be differences to the illustrated device and equipment. Misprints and errors excepted. Colour deviations may occur due to printing technology.

Copyright by RECK-Technik GmbH & Co. KG. All rights reserved. No part of this publication may be reproduced in any form or by any means without the written permission of RECK.

MOTOmed has also been tested in accordance with DIN EN 60601-1-11 and thus meets the special requirements for medical electrical equipment for care in domestic environments.

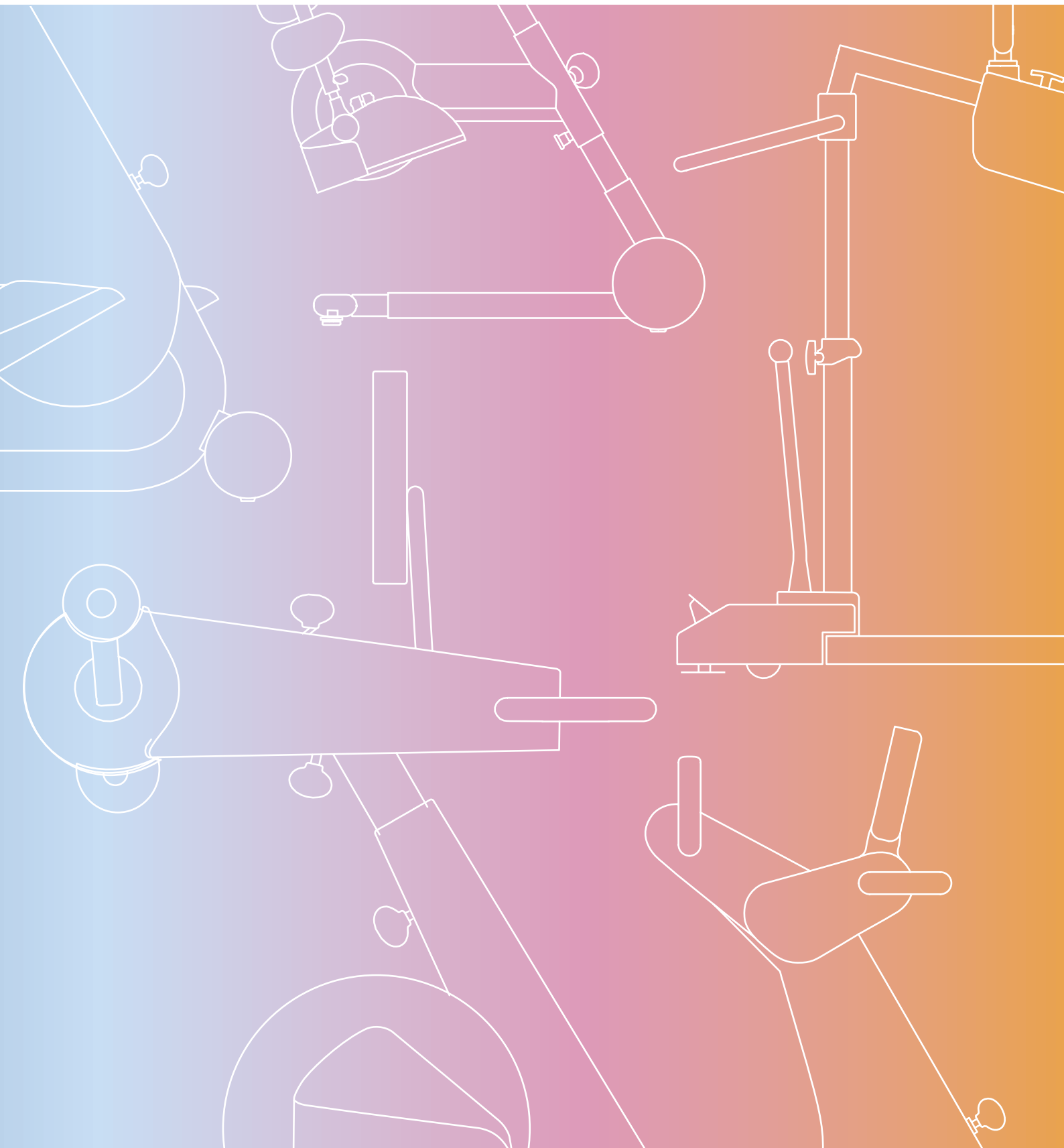

RECK

RECK-Technik GmbH & Co. KG
Reckstrasse 1-5
88422 Betzenweiler
GERMANY

Phone +49 7374 18-85
Fax +49 7374 18-480
info@motomed.com
www.motomed.com

en
IDN 100015.260
As of: 190101